

# LADDOMATIC®

## Manual and installation instructions

ErP  
READY  
2015

APPLIES TO  
EUROPEAN  
DIRECTIVE  
FOR ENERGY  
RELATED  
PRODUCTS

## Function

### Thermal layering

Thanks to its design and control features, the Laddomatic means optimal thermal layering in storage tanks, with a low and even charging flow. This layering system is beneficial as it increases storage capacity.

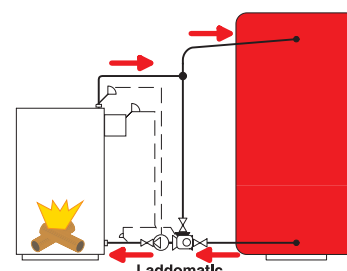
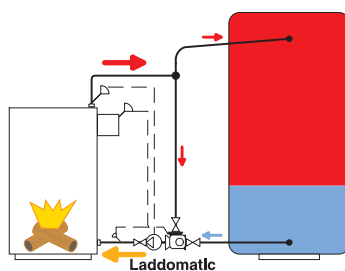
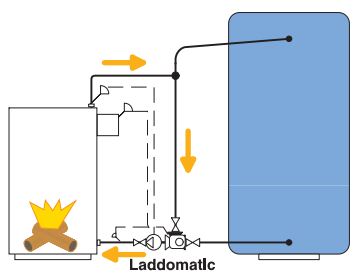
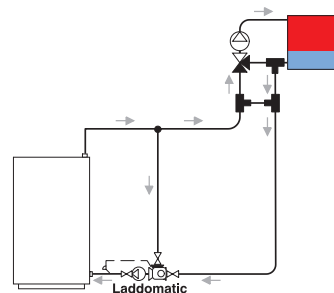
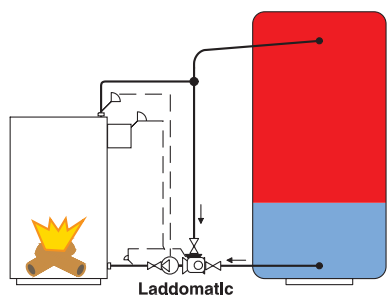

#### Start up phase

Laddomatic enables the boiler to attain working temperature in a very short space of time. This improves boiler efficiency.

During the start up phase, the water is only circulating internally in the boiler

#### Operating phase

Laddomatic charges the storage tank by means of a slow flow of hot water to obtain optimal thermal layering.

During operating phase, Laddomatic will mix hot water from the boiler with colder water from the storage tank.

#### Final phase

The storage tank becomes fully charged and all flow from the boiler goes directly to the storage tank.



## Technical data

Pump:	Wilo Yonos Para 6 Wilo Yonos Para 7,5 Wilo Yonos Maxo 10 Wilo Yonos Maxo 12
Flow characteristics:	Linear / Kvs 10 / Kvs 18
Connections:	3 x R32 with integrated thermometers
Max output:	240 kW
Actuator choice:	Thermomatic TVM, actuator only (for external control) Thermomatic CC, Constant temp. controller

## Connection

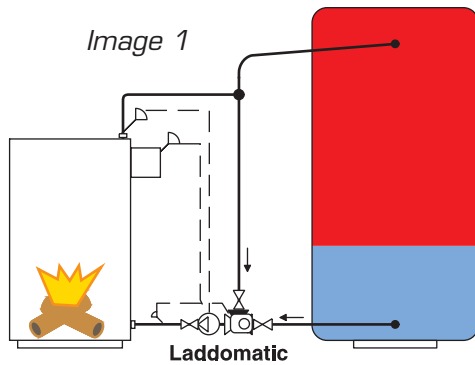

*Shut off valves are installed to facilitate servicing.  
Laddomatic is recommended to be placed low to avoid  
keeping the valve hot between firings.*

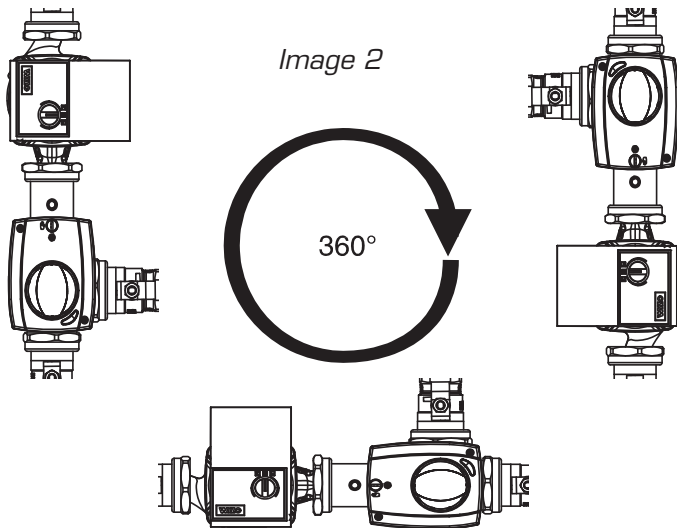

*The installation position does not affect the  
function of the valve.  
The pipes must be connected to the  
correct part on the valve.*

# Installation of Laddomatic

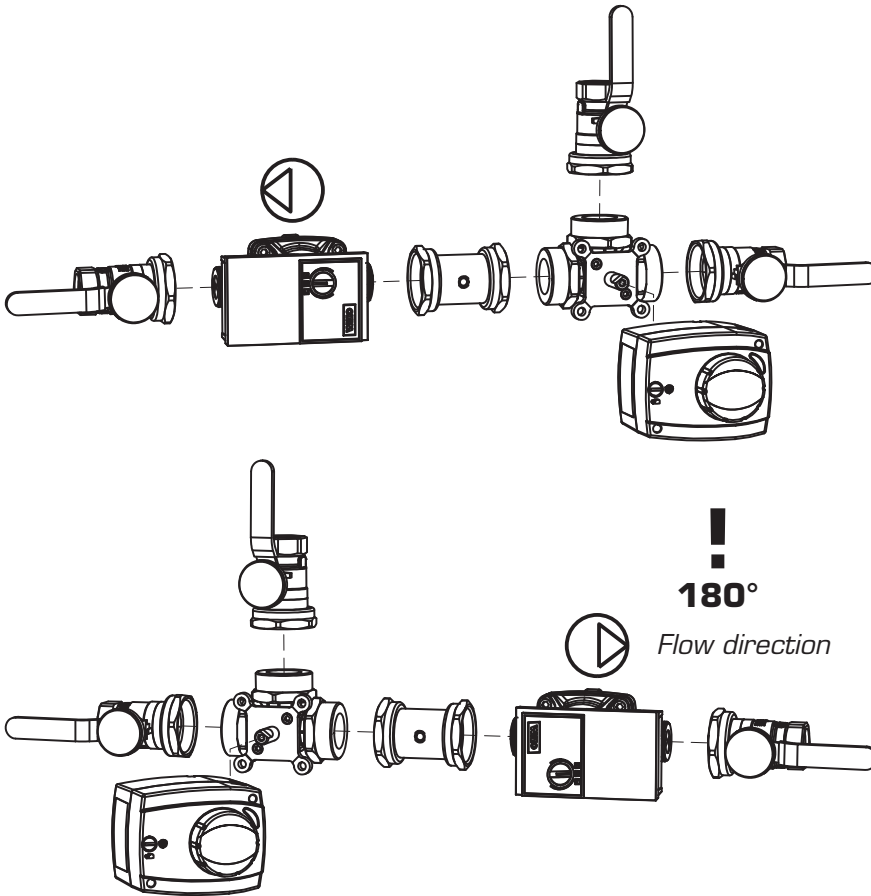

## Pump instruction

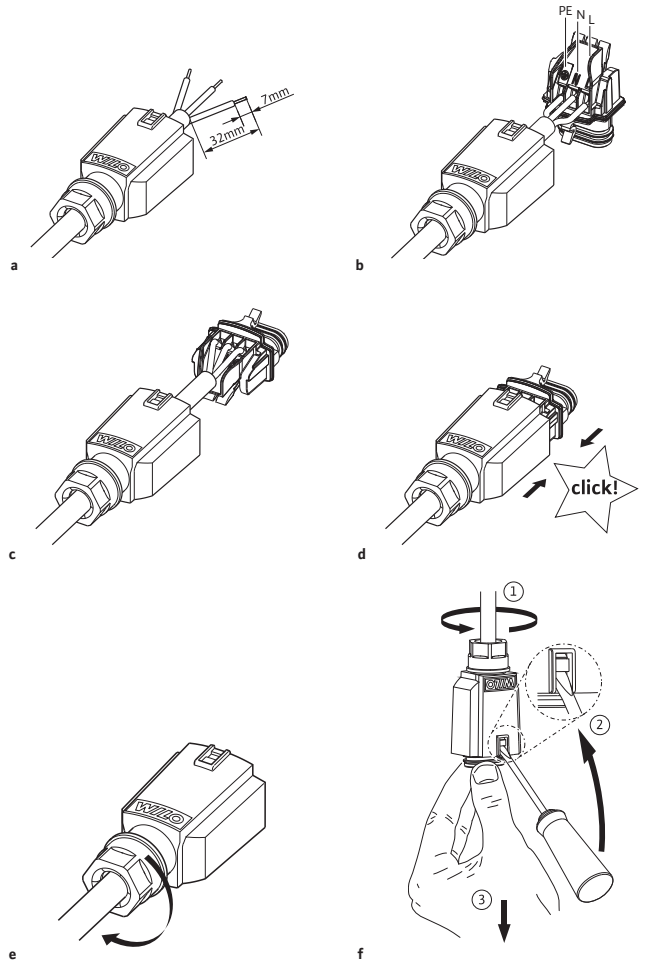
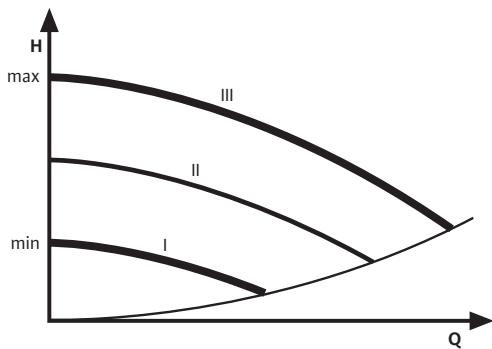
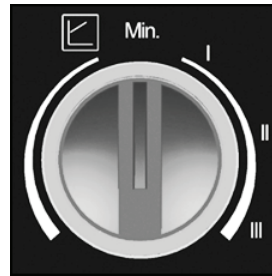
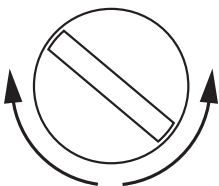

## Starting the pump

See image 3-6.

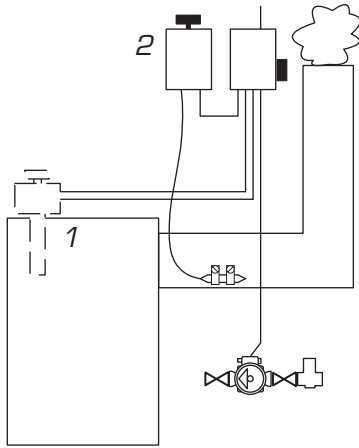

Image 3

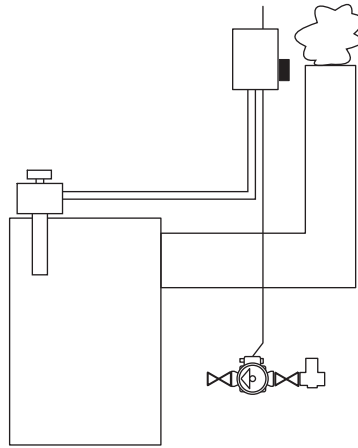

Image 5

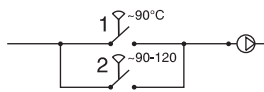

Image 4

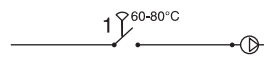

Image 6

### Pump start alternative

On, for example, pellet burners the pump can be started and stopped at the same time as the burner.

## Settings Thermomatic CC

Temperature and rotation are the only settings needed.

NOTE changes are not needed if default values (see table below) are correct for the installation. For installation of actuator and more advanced settings, see complete instruction included with Thermomatic CC.

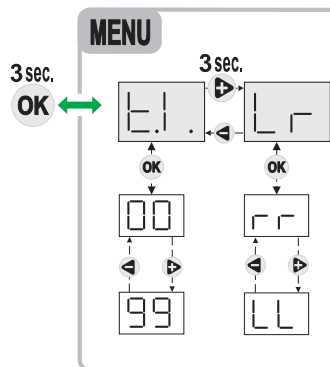
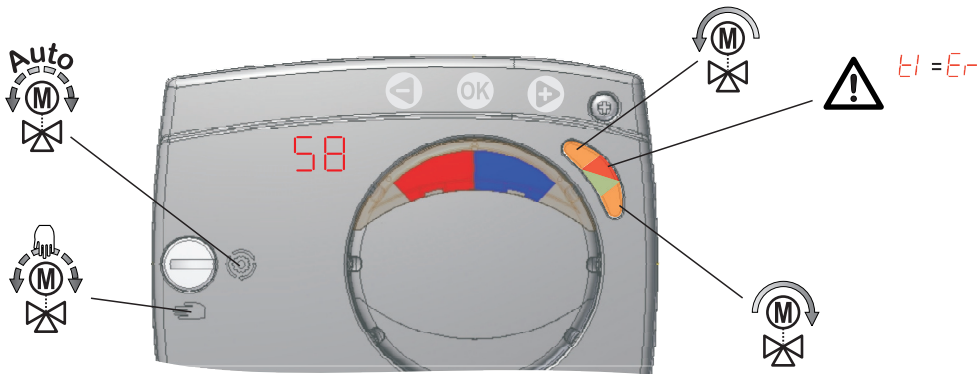

### Rotation

LL = Boiler on left side

rr = Boiler on right side

Parameter	Parameter description	Setting range	Default value
E1	Setting of requested pipe temperature. Controller maintains this temperature by 3-point control of mixing valve.	0 ÷ 99 °C	60°C
Lr	Setting of valve opening direction. LL - Clockwise opening direction rr - Counter clockwise opening direction	LL - rr	rr

### Technical specifications

Power supply = 230 VAC, 50 Hz

Power consumption = <1 VA

Sensor = Pt1000 (1080 Ω 20 °C)

Torque = 13 Nm

Running angle = 2 min/90°

Controller type = PID

Software class = A

Safety class = I

Degree of protection = IP42

Size (L x W x H) = 103 x 84 x 92 mm

Storage temperature = -20 ÷ 65 °C

Operation temperature = 0 ÷ 60 °C

Humidity = 0 ÷ 80 % Rh, non condensing